

(Mostly) easy PCB manufacture

by [guerroloco](#) on April 28, 2006

Table of Contents

intro: (Mostly) easy PCB manufacture	2
step 1: Create your design	2
step 2: Print the masks	3
step 3: Prepare the blank board	3
step 4: Attach the mask to the blank board	4
step 5: Iron!	4
step 6: Soak off the paper	5
step 7: Etch	5
step 8: Clean off the mask	6
step 9: Apply the silkscreen layer	6
step 10: Drill the holes	7
step 11: Finished!	7
Related Instructables	8
Advertisements	8
Customized Instructable T-shirts	8
Comments	8

intro: (Mostly) easy PCB manufacture

This is an easy way to create your own PCBs at home. The method is based on the "5 Bears" process (which is itself based on Tom Gootee's process). I've added a couple of refinements.

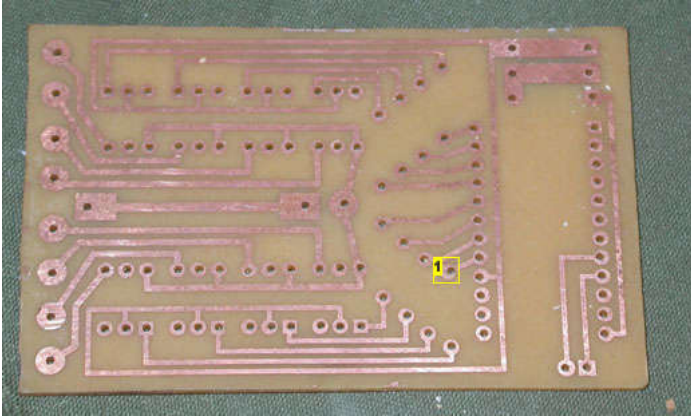

Image Notes

1. one badly drilled hole.

step 1: Create your design

Start out by laying out the PCB traces & pads with your favorite CAD or PCB design program. I used Pad2Pad, mainly because I found that program pretty easy to use, and it's free for download. You're supposed to use Pad2Pad to design a board, then send the file to the company for manufacture. Instead, I use this design to create my own etching mask.

Unfortunately, you can't export p2p files into other formats. So, I printed the board layout to a PDF, then opened the PDF into Illustrator, which allowed me to clean up & fine-tune the design and separate it into layers. This technique is for creating single-sided PCBs, so I made two masks: One for the copper traces & pads, the other for the silkscreen. You need to print out a mirror image of your masks -- you'll see why soon -- but because the traces go on the back of the board, you can print those out normally. The silkscreen mask should be printed out in reverse.

I use 2pt lines for most of the traces; that comes out to about 0.028".

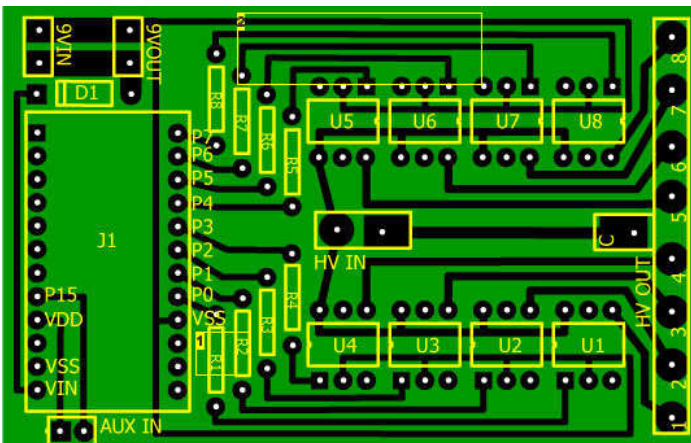

Image Notes

1. The yellow items are the "silkscreen" -- this will go on the front of the board, so you have to print out the mask as a mirror image.
2. The black lines are the traces. Note that these will go on the BACK of the board, so imagine this image as though you're looking through a transparent board. The masks are ironed on, so they need to be made as mirror images. However, because the copper traces will be on the back of the board, we are already looking that them in the correct orientation. So print the traces normally (see next step).

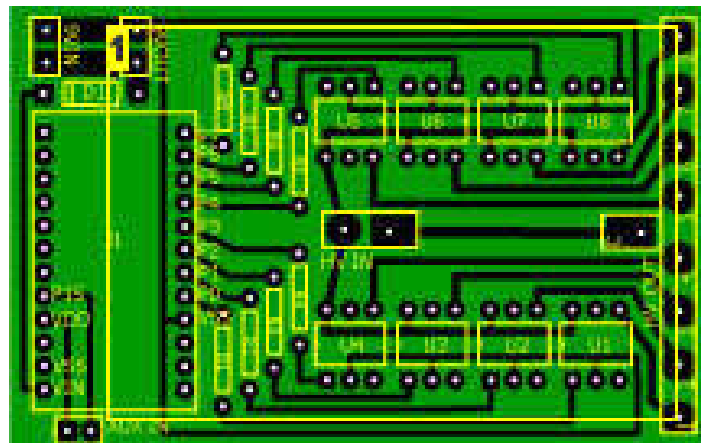

Image Notes

1. this is the actual size. Make sure your traces and gaps are wide enough.

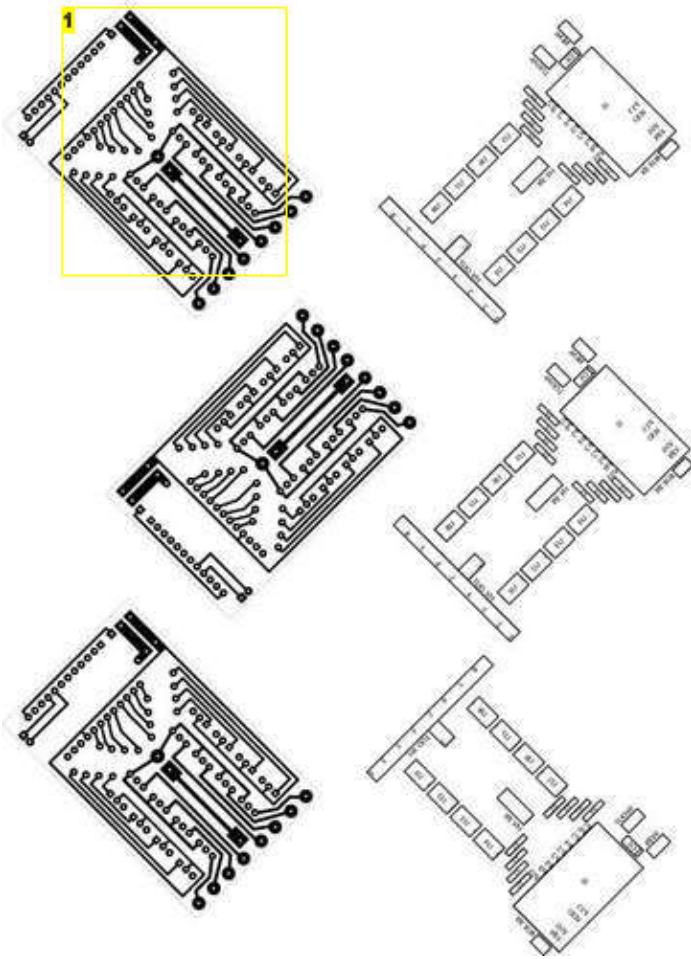

Image Notes

1. Here's the board prepared for printing. Trace mask on the left, silk mask (mirror image) on the right. I print several copies of each for "insurance", because the printouts are rarely perfect. Also, I print the masks at 45 degree angles, because sometimes the toner gets too thin if you try to print long vertical lines.

step 2: Print the masks

This is a tricky step. You need to print the masks onto special paper, and make them as dark as possible. Here's how I did it. I used Jet Print Multi-Project glossy photo paper. I had to order it online, but it might be available at larger office supply stores. Tom Gootee recommends Staples "Picture Paper"; that seems easier to obtain. Unfortunately I didn't read Gootee's article until AFTER I'd already gotten the Jet Print paper. So the Staples paper might be better.

These papers are marketed as ink-jet papers. But for this process, you need to run them through a laser printer. The toner creates the mask. And, you want the toner to be as dark and dense as possible. I found that if you tell the printer that you're printing a transparency, it'll apply more toner. I also adjust various settings on the printer menu (e.g., toner density, optimization, etc.) to get the densest possible print -- your printer settings will vary. Experiment to see what works best, and take notes as you go so you'll be able to duplicate your best efforts later. I burned through quite a bit of paper before I got it right, but now I get it right the first time.

If your PCB design has long vertical traces, you might orient the design on the page so that the long traces are angled. Because of the direction that paper travels through laser printers, long vertical traces might lose toner density near the bottom. Angling the long traces helps keep the toner dense on the full length.

Remember to print the copper mask "right-reading" -- i.e. NOT a mirror image -- but the "silkscreen" mask should be printed in reverse.

Make a print or two and find a mask that is uniformly dense with a minimum of pinholes. Make sure all the traces and pads are complete.

step 3: Prepare the blank board

Cut your board to size, leaving a little extra room around the edges. I use a hacksaw, which leaves some burrs. Smooth any burrs off with a dremel or small file. You want the copper surface to be as flat as possible. Sand the surface of the blank board with 400-600 grit sandpaper in both diagonal directions in a crosshatch pattern. Then, use acetone on a paper towel to clean the board as thoroughly as possible. Grease spots are your enemy! Scrub the board really well.

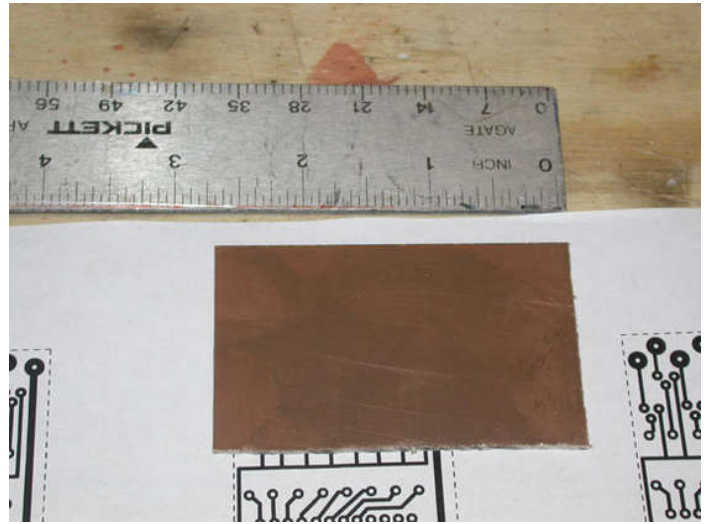
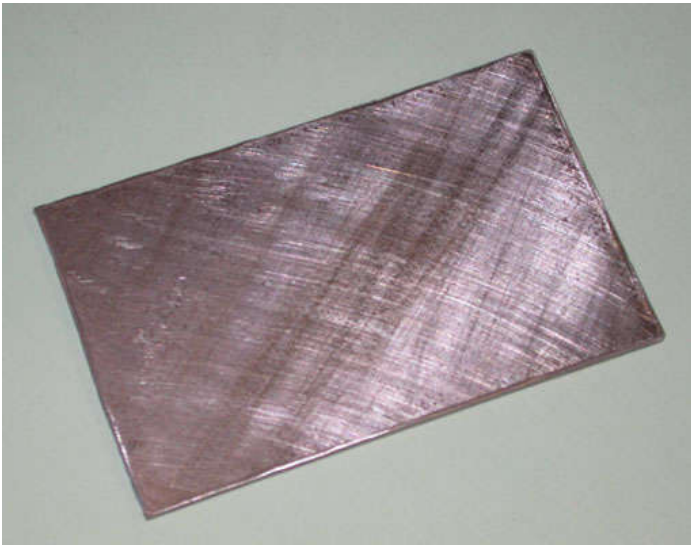

step 4: Attach the mask to the blank board

Carefully cut out the mask for the copper side from your printout. Place it face-down onto your board, so that the toner faces the copper. I use tiny bits of scotch tape on each edge to hold the mask in place. That might not be necessary if your blank is somewhat larger than your mask. I found that the mask tends to slide if it's not securely taped; you want to avoid that when working with tight tolerances.



Image Notes

1. Mask taped to board, toner facing copper. The paper napkin prevents it from sticking to the iron (see next step).

step 5: Iron!

This is the trickiest step. You need to set your iron to its highest setting, no steam. Lay a paper towel over the board & mask; otherwise, the sticky melted plastic that oozes out from under the edges of the mask will cause the whole thing to stick to your iron.

When first applying the iron, press straight down and try not to wiggle or slide the mask. The plastic surface layer of the paper will melt instantly, forming a temporarily slippery layer, which will tend to slide around if you're not careful. This is where it's easiest to screw up, I think.

Start by applying steady, firm pressure to the whole board for one minute, moving the iron occasionally to make sure that the whole board is heated thoroughly. After that, the mask is pretty much stuck to the board, so now you can go over the whole board with the edge of the iron, a little at a time. I use the edge of the iron & lean on it some, putting good heavy pressure lengthwise along the board. Then I move the iron a quarter inch or so and repeat until the whole board is covered. Then I do the same series of "pressure lines" widthwise across the board. Finally, I finish with overall pressure for a few more seconds. The total ironing time is maybe 3 minutes, tops.

step 6: Soak off the paper

Drop the hot board immediately into a pan of hot water, along with any of the paper towel that might be attached. Some of the paper will start to come off right away. Help it along! After a few minutes, more paper can be pulled off. Also peel off any scotch tape you used to hold the mask to the board. After 10-20 minutes, you'll be down to the last layer, which is more like plastic than paper. The traces will be clearly visible though it. Get a corner started, and the plastic should peel off easily, leaving you with a nicely masked board. If you've ironed well enough, the toner will be fused to the board solidly; it can't be scraped off with a fingernail.

If the traces are messed up in any way -- for example, if the iron slipped -- you can clean off the fused toner with acetone and start over with a fresh mask.



Image Notes

1. another layer of paper peeling back....

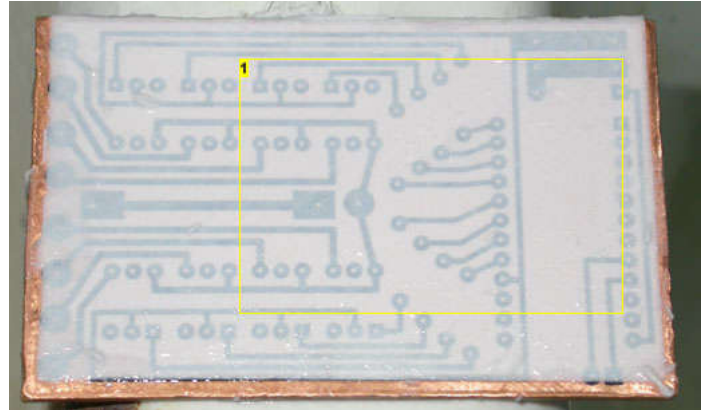

Image Notes

1. Down to the last layer -- traces clearly visible

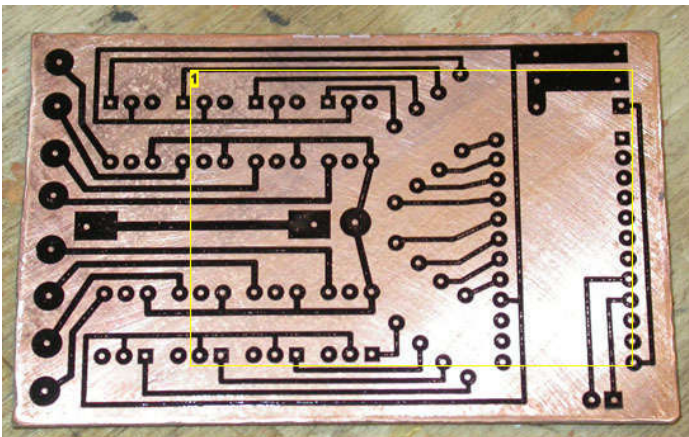

Image Notes

1. dry it off and you're ready for the next step....

step 7: Etch

Drop the board into your etch solution. Don't let the etch chemical get onto anything made of metal! I use a large plastic container. Etch the board until the remaining copper is gone. Depending on how fresh & warm the etch chemical is, it could take 10-30 minutes.



Image Notes

1. I think I didn't clean the board properly here. You can hurry the etching along in "trouble spots" like these, by scratching the areas with an exacto blade
2. I use a plastic fork to stir the etchant and retrieve the board to inspect the progress.
3. Almost finished.... still a little copper left here

step 8: Clean off the mask

Use acetone to clean off the toner. You'll be left with a nice shiny circuit board!

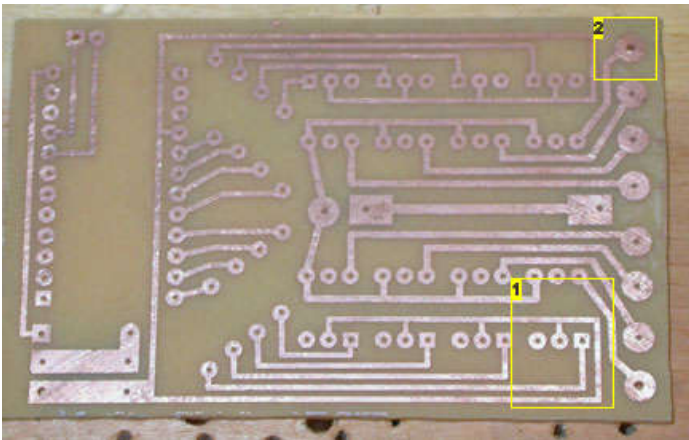

Image Notes

1. the photo's blurry, but these traces are nice and sharp!
2. Drill corner holes for next step.....

step 9: Apply the silkscreen layer

Now it's time to add the "silkscreen" to the other side of the board. It's not really a silkscreen; it's actually the same process as described above, except that you leave the fused toner on the board and don't do the etch and cleanoff.

To align the "silk", I drill a hole in the four cornermost pads. After cutting out the silk mask, I place it toner-side-down against the side of the board opposite the traces. Holding it up to the light, you should be able to see the four corner holes through the mask. Use these to line up the silk mask properly, then tape it to the board with scotch tape. Next, iron the board the same way you did the copper side, and finally soak off the paper as in step 6.

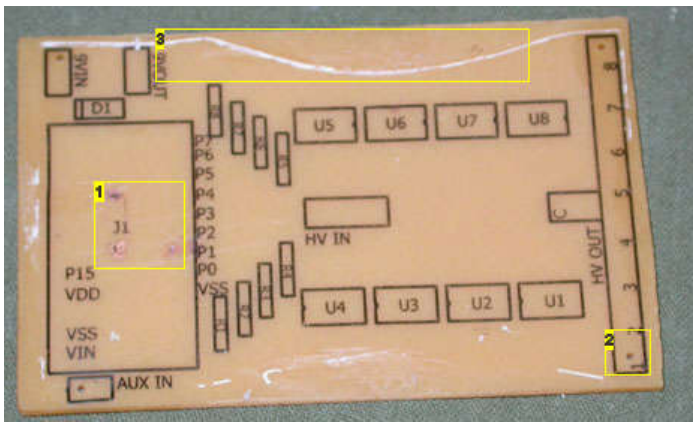

Image Notes

1. a few small patches of copper left over from etching the other side. (This was a double-sided board.) My etchant was used and somewhat weak.
2. holes drilled in each corner to help align the silk before ironing
3. remnants of the paper mask. I've found that the edges of the mask sometimes leave a gummy residue that can be hard to remove. I don't really find this objectionable. If you use solvent to remove this residue, be careful not to remove the fused toner as well.....

step 10: Drill the holes

This is a little tricky, but can be done without requiring a drill press or other fancy equipment. I use a dremel tool with a #60 bit. That's the smallest bit I can find at the local hardware store. The bit is clamped into a collet, which in turn is held in the dremel's chuck.

Here's my secret to drilling lots of tiny holes with a hand-held drill: use a scrap piece of acrylic as a drill guide. Drill a hole in the acrylic, then drill through that hole and through the board. The clear acrylic makes it easy to line up the drill bit correctly on the center of each pad. After a dozen holes or so, the "guide hole" in the acrylic will start to "loosen up" -- just drill another guide hole & keep going.

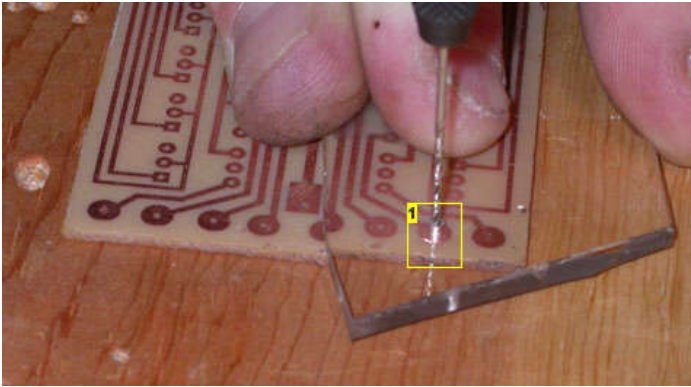

Image Notes

1. The "guide hole" in the acrylic sheet also helps keep the bit from shimmying (

step 11: Finished!

The board is ready to use.

I've made four boards using this method. The first one was perfect, but got ruined by sloppy soldering. The second and fourth were also perfect & worked great in projects. On the third board, I moved the iron when I first applied it, so the mask slipped and blurred some traces.

With a little practice, you can make a board in a couple hours (not counting design time).

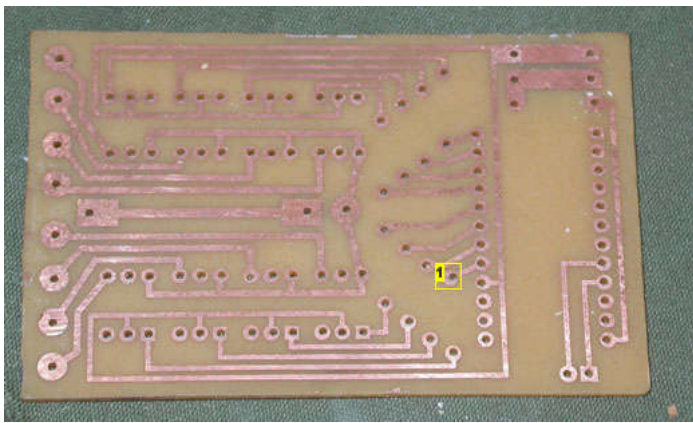

Image Notes

1. one badly drilled hole.

Related Instructables





Comments

[50 comments](#) [Add Comment](#)

[view all 62 comments](#)

 **Seifpic** says: Feb 19, 2009. 10:36 AM [REPLY](#)
I'm not sure why, but this is the best 'make your own PCB' Instructable.

 **vdr20** says: Nov 11, 2008. 1:16 PM [REPLY](#)
I used hp glossy paper.
When I iron the paper onto the board half of the toner stays onto the board no matter how long I iron it on for. What do I do?

 **collard41** says: Oct 17, 2008. 12:23 AM [REPLY](#)
I feel sorry for all of you out there that have to use this method, hard and laborous (did i spell that right!). i go to school and what we do is print out the design on a special type of tracing paper (high quality) and then put it in a UV exposure box with the board, (the board has photo resist on it). and then just dunk it in an etching tank, i cant remeber what chemical we use, it isnt ferric chloride. it takes about 10 mins and then you take it out of there and put it in the special rinsing tank. i dont bother to put a silk screen on because i can just refer to the schematic and layout. i dont use eagle i use Proteus. it costs about £1500, but the school paid for it. it is much better and easier to use. but then it is what professional companies use.

 **buiocchi** says: Aug 30, 2008. 2:30 PM [REPLY](#)
what is the importance of dipping it into the etching liquid?

 **CyberBill** says: Oct 7, 2008. 2:00 PM [REPLY](#)
Etchant essentially eats the copper off of the PCB. The point of doing the toner transfer is so that certain areas of the copper-clad PCB are covered up by toner (a permanent marker does the same thing), and thus protects the copper from being eaten by the etchant.
Afterwards, you just use the fingernail polish remover (acetone) to clean the toner/marker off of the board, which reveals the still in-tact copper below it.

 **sha4096** says: Sep 21, 2008. 7:34 AM [REPLY](#)
I have tried with two Laser printers. The first one, the HP LaserJet P1005 has a great toner and will easily transfer in less than a minute of ironing using paper from magazines. However, the toner tends to melt and you must not press too much when ironing otherwise you will lose details. The second printer, the Brother HL-2000 has a toner which is more thermal-resistant. It is also more prone to paper-jamming. So set the printer settings such that the highest paper thickness is activated. Ironing is more difficult with the Brother toner, I found that the best way for small PCB was to leave the iron on top of the paper and leave for 5 minutes without moving the iron. Heat is the way to go if you want to transfer with Brother toner.

 **nickjohnson** says: Jun 10, 2006. 11:05 AM [REPLY](#)
Very tricky. I tried this with a used iron bought from the salvy. Even at the highest setting, it's probably not as hot as it should be...
First time, I tried no more than 3 minutes, and very little transferred at all. Next, I tried a total of 7 minutes and most of the design was transferred, which I touched up later

 **carpus101** says: Jun 21, 2008. 3:32 AM [REPLY](#)
Hi nick, nice I found yr words here. You see I am trying to find PCB with Iron layer and not copper.
You know how and where to find it??
Appreciate yr advice - roger

 **nickjohnson** says: Jun 10, 2006. 11:07 AM [REPLY](#)
Is there any good way to agitate or heat the etching solution?
I was thinking of using a glass container with a halogen lamp against it, or to put the whole thing on a turntable.

 **Dodgy** says: May 10, 2008. 12:00 PM [REPLY](#)
Constant agitation is virtually **essential**. You can use a brush or a stick to move the board around or to move the etchant over the surface(s) of the board so as to always have some fresh etchant on the copper, and therefore homogenise the dissolved copper.

If the etchant is hotter, it will work better (ferric chloride). But don't make it over about 80deg C, or the fumes could start eating into the copper wiring in your ceiling light (probably not). Or your health may suffer from breathing it in.

Ammonium persulphate apparently needs to be in a window zone of temperature.

As for the hydrochloric acid and hydrogen peroxide method.... Apparently it can become an exothermic reaction and provide heat to itself, eventually exploding... So I wouldn't overheat that, if possible!

 **sumit381** says: May 16, 2007. 2:51 PM [REPLY](#)
Where can I buy this copper board? Is it available at hardware stores like Home Depot, Lowes, etc? And how much do these boards range price-wise? Is there any specific name for this board that I should ask for when I go to the store? Thank you for your help.

 **Dodgy** says: May 10, 2008. 11:29 AM [REPLY](#)
It's called copper clad fibreglass sheet, or blank PCB or FR-4 with Cu coating, or other names you may choose to make up. There is also a phenolic or SRBP type, which is older and sometimes still used today. There is also the type that they use in China for cheaply made TVs & VCRs, and most consumer items not needing a flame retardant ability. Their holes and edges are punched, and the boards are often very flexible, and not reliable if flexed, but hey, they cost them a lot less than the high quality fibreglass PCBs (UL: 94-V0 or FR-4)
You won't find them at hardware stores, but electronics shops.

Price, about Aust./US\$5 for a small board to \$80 for a very large double sided, these are rough prices.
This will give u an idea of what's around. Farnell has locations all around the world.
http://au.farnell.com/jsp/search/browse.jsp?N=500001+1001200&Ntk=gensearch_001&Ntt=pcb&Ntx=

 **guerroloco** says: May 16, 2007. 3:54 PM [REPLY](#)
any radio shack will have these, or you can order online from digikey, all electronics, and hundreds of other vendors.
<http://www.radioshack.com/product/index.jsp?productId=2102495>
http://www.allelectronics.com/cgi-bin/item/PCB-46/search/4%22#34;_X_6%22#34;_SINGLE-SIDED_PC_BOARD_.html

 **sumit381** says: May 16, 2007. 7:33 PM [REPLY](#)
Thank you for your reply.

 **Inovative Invintor Joe** says: Jan 4, 2008. 6:15 PM [REPLY](#)
OK what was the chemical you used to etch the copper?



guerroloco says:

Jan 9, 2008. 6:34 AM [REPLY](#)

It's ferric chloride, commonly available at Radio Shack or any of the online electronics stores. It's kind of nasty stuff. This guy has an instructable that suggests a more benign solution (haha): <http://www.instructables.com/id/Stop-using-Ferric-Chloride-etchant!--A-better-etc/>



OptimusTronic says:

Oct 15, 2007. 10:12 AM [REPLY](#)

Gut Danke, this tutorial very good.

Danke!!

Saludos desde Guatemala!



Swartzkip says:

Sep 11, 2007. 10:42 AM [REPLY](#)

Im new to al this, but as far as i understand the only thing holding of the etching solution back is the toner from the printer. So you should use a paper that leaves al the toner on the bord. (correct?)

A other instructable uses "baking paper" (stuf you use in the oven so that baked goods dont stick to the plate) to transfer designs on tshirts. Maybe that will work too.



Fritzk9 says:

Jul 27, 2007. 11:39 PM [REPLY](#)

On Step 6, you can save a lot of wasted time soaking off the paper backing by printing your PCB pattern on Toner Transfer Film (TTS) instead of paper. TTS film is a thermoplastic film that has a water soluble backing which releases it in about 30 seconds when dipped in water. See details at www.pulsarprof.com under Direct Etch. You can purchase TTS film from Digi-Key (www.digkey.com) for \$14.95 for a 10-sheet pack (Digi-Key stock # 182-1003-ND). Once you've used TTS film, you'll never go back to paper.



LordSTITH says:

Jul 27, 2007. 3:37 AM [REPLY](#)

I printed to the backing sheet of some Avery's labels. Worked great, the paper popped right off when I tossed it in a little cold water. It worked almost too well to believe. I want to see how wax paper works, though, because getting labels purely for PCB making is a tad expensive. I'd like to take my boards to the next level, though. I have a silk screening frame and I want to play with doing a silk-screened documentation layer, but before that I'd like to coat the board in whatever that green insulation is. Anyone know anything about the stuff?



mrpiggss says:

May 30, 2007. 2:11 AM [REPLY](#)

i just tried something and wanted to pass it along. i used HP glossy photo paper and copied onto it with an ordinary toner copier, ironed it on and it popped off leaving the toner behind. i did soak it for a few minutes in cold water. it's the HP photo paper with the real photo backing. it's thick stuff and it works like magic. no real soaking or peeling off layers of paper. i bought the paper at miejer. just thought i'd pass this along. i have 6 good boards in a row of the first try!



i.c.rhodes says:

May 23, 2007. 5:22 PM [REPLY](#)

How would you go about converting a schematic to a pcb layout manually, with no software. I would like to teach students how to do this before they go on to using layout software.



guerroloco says:

May 24, 2007. 7:29 AM [REPLY](#)

If it's a simple circuit, I re-draw the schematic several times until I have a version that has no crossings. If it's more complicated, i'll use a schematic layout software (like ExpressSCH, http://www.expresspcb.com/ExpressPCBhtml/Free_schematic_software.htm) that lets me move connected components around. It might require running connections between terminals (or "through" or underneath components -- see U1-U8 in my picture to see what i mean). The goal here is not compactness or even relative position of components, it's just good topology with fewest crossings (which would require jumpers). I also try to move similar off-board terminals close to each other (for example, power supply + and -). Once I have a design with the least number of crossings, I'll use a PCB layout program, add all the components, arrange them more-or-less like my improved schematic, and connect them. At that point I can move them closer together, rotate, shorten/simplify trace routing, etc.



i.c.rhodes says:

May 23, 2007. 5:26 PM [REPLY](#)

How would you go about converting a schematic to a pcb layout manually, with no software. I would like to teach students how to do this before they go on to using layout software.



sumit381 says:

May 17, 2007. 10:23 AM [REPLY](#)

Is there any precaution I need to take when I dispose of the etch solution? For example; would be ok to dump the solution down the drain or not? And if not, how should I dispose of it once I'm done? Thanks.



guerroloco says:

May 17, 2007. 11:11 AM [REPLY](#)

Do **NOT** dump ferric chloride etch down the drain!!!

You can dispose of it at your local hazardous waste disposal company (in my town, we have municipal hazardous waste drop-off dates).

Or, you can add sodium carbonate (washing soda) or sodium hydroxide (AKA lye or Drain-o) to neutralize it, until the pH value goes up to between 7.0 and 8.0. Test it with litmus paper. Copper will be deposited as a sludge. Allow the sludge to settle, pour off the liquid, further dilute it with water and then it can be poured down the drain. Collect the sludge in plastic bags and dispose of it as required by your local waste authority.



Eriswerks says:

Mar 8, 2007. 3:32 PM [REPLY](#)

I recently tried toner transfer PCB making for the first time, and here's what I found out.

First, the type of paper you use really matters. Staples "photo basic paper" was the only thing that worked well for me.

Second, the more ironing the better. I didn't iron one edge of my board well enough, and ended up with some bad traces. (I fixed them with a Sharpie.) Next time I want to place something flatter and harder than my ironing board underneath the PCB so I can press the thing down properly.

Third, I used 1 part muriatic acid and 3 parts hydrogen peroxide as my etchant with good results. The muriatic acid is dirt cheap at pool supply stores and hardware stores.

And finally, the toner was fiendishly difficult to get off after etching, even with acetone. I had to use some fine sandpaper on it to finish the job.



guerroloco says:

Apr 5, 2007. 8:12 AM [REPLY](#)

yah, I iron my boards on a good hard chunk of wood (piece of a 1x6) with a piece of scrap denim laid over the wood for just a little "give".

I never had any problem removing leftover toner with acetone. Maybe you're ironing too hard :)



x_pyro says:

Feb 24, 2007. 3:40 PM [REPLY](#)

Hey where did you get your etching stuff from? i cant seem to find any.



guerroloco says:

Feb 25, 2007. 9:36 PM [REPLY](#)

I picked some up at the local Radio Shack, but you can get it online lots of places as well. It's sold in powder form. Look for anhydrous ferric chloride. for example [here](#)



sumguysr says:

Jan 31, 2007. 11:11 PM [REPLY](#)

I am very interested in hobby pcb production and thus have been researching it quite a bit. While I have no practical experience(yet) I have read that the best paper to use for toner transfer is the waxy backing that laser printer labels come on. after ironing it just peels right off with out any of the soak and cleanup ordeal. Also you can get much cleaner and more consistent results by running the board through a laminator a few times rather than ironing.



zus says:

Dec 19, 2006. 8:20 PM [REPLY](#)

Thank you very much great instructable im gonna get started doing this as soon as the break starts :)



Gnaw says:

Dec 1, 2006. 6:42 AM [REPLY](#)

Great instructable, I cant wait to try it!



JJ_Jackson1 says:

Apr 28, 2006. 2:06 PM [REPLY](#)

Could you use the same sheets that are use for transfer onto t--shirts?



zachninme says:

Nov 15, 2006. 7:46 PM [REPLY](#)

And no, you can't use photo-paper for your inkjet photo printer. It doesn't stick at all...



xenobiologista says:

May 5, 2006. 3:31 PM [REPLY](#)

Melts in laser printers. Found out the hard way =(



radiorental says:

Apr 28, 2006. 2:53 PM [REPLY](#)

probably not, they dont generally stick to non porous surfaces and would probably leave a huge waxy mess and then the ink would run in the acid bath most likely.



zachninme says:

Nov 15, 2006. 7:48 PM [REPLY](#)

Do you think it would work with photo paper designed for Laser printers? Or does that just not work?



radiorental says:

Apr 28, 2006. 12:07 PM [REPLY](#)

wow, thats pretty easy. Now its been many a year since I worked a homebrew pcb (mostly uv masking) bt I recall some pen you could get to go over the the mask with this process to patch up where the toner didnt take. Any ideas?

cool project



asguard says:

Dalo pens, if you can't get them (most electronic shops have them), you can use/try, Staedtler Red permanent marker.

With regard picture above looks more like missed with drill.

Oct 19, 2006. 6:26 AM [REPLY](#)



guerroloco says:

yeah, they sell those at radio shack & elsewhere. It's conductive ink.

Apr 28, 2006. 12:59 PM [REPLY](#)



radiorental says:

I think thats for after etch no?

I was wondering if there was an ink that could be used in the acid. Instead of re-starting from scratch if the iron transfer didnt go 100%. Or is that not really a problem?

Apr 28, 2006. 1:23 PM [REPLY](#)



Eriswerks says:

I just tried this, and a black Sharpie-brand permanent marker does indeed work. Just make sure you draw a nice, solid line.

Mar 8, 2007. 3:21 PM [REPLY](#)



guerroloco says:

Ahh, I see what you mean. Something to fix the pinholes or whatever on the fused toner before etching. Hmm, good question. Tom Gootee's site says you can make small corrections "using a Sharpie or other etch-resistant marker pen." I haven't tried that

Apr 28, 2006. 3:25 PM [REPLY](#)



radiorental says:

all I needed to know 'sharpie' anything that will stop the acid etch. Thanks.

p.s. you won first prize in spot the mirroring mistake (o;

Apr 28, 2006. 9:36 PM [REPLY](#)



zachninme says:

So sharpies do the thing? Good!

So in theory, I can draw the whole the board out using a sharpie? Not pretty, but it would work!

Nov 15, 2006. 7:45 PM [REPLY](#)



James (pseudo-geek) says:

probably, I was thinking the same thing. make a stencil and then use a sharpie with it.

Apr 23, 2007. 1:45 PM [REPLY](#)



sprocketsci says:

You could do the whole board with a sharpie. A normal sharpie should work fine but if you want to be sure use an "industrial" sharpie it claims to resist chemical washes and withstand higher temps.

Mar 21, 2007. 2:38 PM [REPLY](#)



bfr says:

You really can't beat press n peel :-)

Aug 9, 2006. 3:50 AM [REPLY](#)



pfred1 says:

You must be good at ironing can you come over and do some shirts for me? :) That and even if the stuff fully sticks there are resolution issues. I just about maxxed out the process with my last board. I was doing a lot of knife scraping with that one! It is not easy getting traces between IC legs with PNP Blue.

Oct 11, 2006. 5:54 PM [REPLY](#)

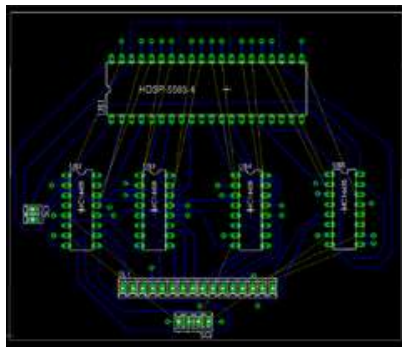

[view all 62 comments](#)